

00188218
(DR200BT)

hama



Portable Digital Radio

Portables Digitalradio

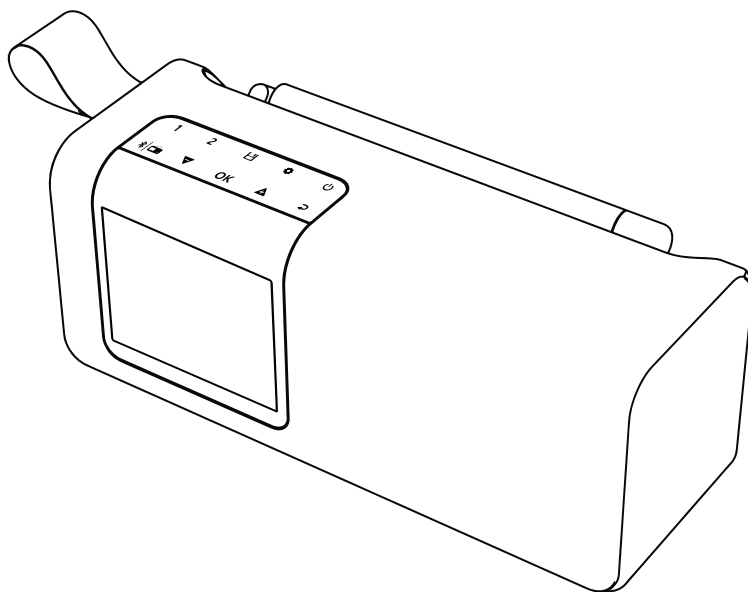

Operating Instructions / Bedienungsanleitung / Mode d'emploi / Instrucciones de uso /
Руководство по эксплуатации / Istruzioni per l'uso / Gebruiksaanwijzing / Οδηγίες χρήσης / Instrukcja obsługi /
Használati útmutató / Návod k použití / Návod na použitie / Manual de instruções / Kullanna käsiraavu /
Manual de utilizare / Bruksanvisning / Käyttöohje / Работна инструкция / Betjeningsvejledning / Manuelt stasjonsbok

Technical Data

Technische Daten

Display	2.4" (6.10cm) Color TFT
Speaker / Lautsprecher	5 Watt
Charging Voltage / Ladespannung	5V / 1A
Battery Type / Batterie Typ	Li-Ion, 3.7V, 2000mAh / 7.4 Wh
UI Languages UI Sprachen	English, German, Danish, Dutch, Finnish, French, Italian, Norwegian, Polish, Portuguese, Spanish, Swedish, Turkish, Czech, Slovak
Packaging Content Verpackungsinhalt	Digital Radio, USB-C Charging Cable, Quick Start Manual

Connectivity

Konnektivität

Bluetooth	v5.0
------------------	------

Audio Connectors

Audio Anschlüsse

Inputs	USB-C, AUX-In
---------------	---------------

Sources

Quellen

Presets

Favoriten



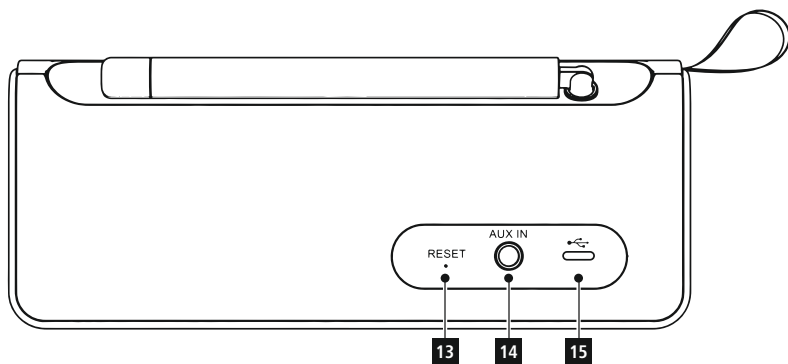
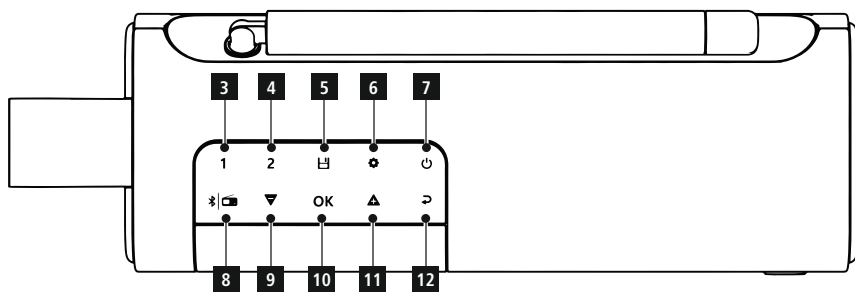
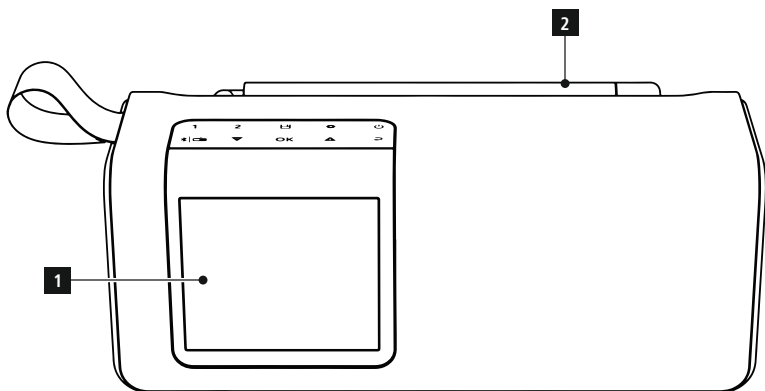



Sources Quellen		Presets Favoriten
DAB/DAB+ (174.928 - 239.2 MHz)	✓	30
FM (87.5 - 108 MHz)	✓	30



Controls and displays**A: Front**

1		Display
2		Telescopic aerial

B: Radio control panel

3	1	[PRESET 1] button
4	2	[PRESET 2] button
5		[PRESET] button
6		[MENU] button
7		[POWER] button
8		[MODE] button
9		[VOLUME] / [NAVIGATE] – button
10	OK	[OK] / [ENTER]
11		[VOLUME] / [NAVIGATE] + button
12		[BACK] button

C: Rear

13		RESET
14		AUX-in socket
15		USB-C socket

1. Explanation of warning symbols and notes

Risk of electric shock



This symbol indicates a risk of electric shock from touching product parts carrying hazardous voltage.

Warning



This symbol is used to indicate safety instructions or to draw your attention to specific hazards and risks.

Note



This symbol is used to indicate additional information or important notes.

2. Package contents

- Hama "DR200BT"
- USB-C charging cable
- Quick-reference guide

3. Safety instructions

- The product is intended for private, non-commercial use only.
- Do not use the product in areas in which electronic products are not permitted.
- Protect the product from dirt, moisture and overheating and use it in dry rooms only.
- As with all electrical products, this device should be kept out of the reach of children.
- Do not drop the product and do not expose it to any major shocks.
- Do not operate the product outside the power limits specified in the technical data.
- Keep the packaging material out of the reach of children due to the risk of suffocation.
- Dispose of packaging material immediately in accordance with the locally applicable regulations.
- Do not modify the device in any way. Doing so voids the warranty.
- Use the product only for the intended purpose.
- Do not use the product in the immediate vicinity of heaters, other heat sources or in direct sunlight.
- Do not use the product in a damp environment and avoid splashing water.
- Only use the article under moderate climatic conditions.
- The battery is integrated and cannot be removed.
- Do not incinerate the battery or the product.

- Do not tamper with or damage/heat/disassemble the batteries/rechargeable batteries.
- Route all cables so that there is no risk of tripping.
- Do not bend or crush the cable.

Risk of electric shock



- Do not open the device or continue to operate it if it becomes damaged.
- Do not use the product if the AC adapter, the adapter cable or the mains cable are damaged.
- Do not attempt to service or repair the product yourself. Leave any and all service work to qualified experts.

4. Charging the battery

Warning – rechargeable battery

- Only use suitable charging devices or USB connections to charge the product.
 - Do not use defective chargers or USB ports and do not attempt to repair them.
 - Do not overcharge the product or allow the battery to completely discharge.
 - Avoid storing, charging and using in extreme temperatures and at extremely low atmospheric pressures (such as at high altitudes).
 - Charge regularly (at least quarterly) during periods of prolonged storage.
-
- The product contains a rechargeable battery.
 - Fully charge the product once before using it for the first time.
 - Connect the supplied USB-C charging cable to the USB-C connection (15) on the product.
 - Connect the free plug on the USB-C charging cable to a suitable USB charger. To do this, consult the operating instructions for the USB charger you are using.
 - The actual battery life will vary depending on how you use the device, the settings and the environmental conditions (batteries have a limited life).

Note – charging process



- A complete charging cycle takes about 3 hours.
- The product's battery can be charged both when it is switched on and off.

5. Start-up and operation

Note - optimising reception



- At the initial start-up, the system interface will ask about the preferred language. Select your preferred language.
- A station search in DAB operating mode is automatically started when you switch the radio on for the first time.

Please note:

- Always pull the antenna out completely.
- We recommend you adjust the antenna vertically to ensure optimal reception.

5.1 General notes on use

5.1.1 Switch On / Off / Standby

- Press (7) to switch the radio on.
- Press (7) for approx. 1 second to switch the radio off.

Note



- If the radio is switched off completely when in battery power mode, timers and sleep timers that have been set will no longer be valid. Confirm the prompt that appears on the display with (OK).
- If the radio is switched off while in mains power mode, the device will switch to standby.

5.1.2 Navigation and control

- See the table attached for this.

6. Menu structure

MAIN MENU

Digital radio

Station list
DAB tuning
Volume adjustment

Bluetooth

Pairing a new device

VHF

Search settings
Audio settings

Aux In

AUX Priority

Routines

Timer
Sleep timer

Settings

Audio settings

Equaliser

Screen settings

Backlight

Colour scheme

Night mode

System settings

Time/date

Language

Automatic switch-off

Software update

Factory settings

7. Main menu

The main menu includes the radio's most important functions, as well as a number of additional functions that are summarised under Point **12. Routines**.

You can always access the main menu by pressing the button (6) and via the menu item "**Main menu**".

8. Digital radio

If "**Digital Radio**" operating mode has been selected, the [⚙️] button (6) provides access to the following setting options:

- **Station list**

Here you will find a list of all stations that were found during the last search. Radio stations that are not currently receivable because there is insufficient signal strength are marked with a "?" in front of them.

- **DAB tuning**

- **Full scan**

All receivable frequency bands are scanned in a new search.

- **Manual setting**

Only a specific frequency block is searched for receivable stations. This is an option if you know which frequency block specific radio stations are broadcast on.

- **Delete unreceivable stations**

All stations that have a "?" in front of them in the station list are deleted from the station list.

- **Volume adjustment**

Automatic volume adjustment can compensate for fluctuations in volume. If there is a significant increase in volume, the radio endeavours to automatically compensate this fluctuation. You can define whether this adaptation is to happen to a greater or lesser degree, or whether it is to be disabled completely.

9. Bluetooth

When Bluetooth mode is enabled for the first time, the radio is immediately in "**Pairing mode**" and visible to other devices. You can therefore pair the radio with your smartphone, for example, and begin transmitting from the relevant source device.

If the radio has already been paired to a smartphone, the next time Bluetooth mode is enabled, the connection is automatically established.

To pair a new radio, press the [OK] button (10) or call up the Bluetooth menu using the [⚙️] button (6) and select "**Pair new device**".

To learn how to operate the radio during Bluetooth playback, consult the **Control Panel**.

10. VHF

The radio automatically searches for analogue radio stations that can be received in the current location with sufficient quality.

To find the nearest station, start the search with the [OK] button (10).

- **Search settings**

Define here whether the search is to stop at stations that can be received with a sufficient signal strength, or should also include those with weak reception.

- **Audio settings**

Define whether the radio should attempt to play back stereo signals or whether analogue radio stations should always be played in mono quality.

11. AUX In

AUX IN mode allows a cabled connection to be established between another audio source and this device. The volume can be controlled via this radio. All other operations are carried out via the connected audio source.

- **AUX Priority**

This function defines how the radio is to behave if an AUX connection is present. If this function is enabled, the radio automatically switches to AUX IN mode and remains in this mode if a 3.5 mm audio cable is connected to the relevant socket on the radio. If disabled, the user must manually switch the radio to AUX IN mode.

12. Routines

This area groups together the radio's additional functions, which have time-controlled features.

• **Timer**

The timer can be set with minute-by-minute precision and offers a range from one to 99 minutes. To start the timer, press the [OK] button (10). Pressing the [OK] button (10) again pauses or stops the timer. The navigation keys allow you to change an active timer and restart it with [OK] (10).

Once the timer has reached its set limit, a signal sound is heard - even if radio playback is also currently active.

• **Sleep timer**

The radio has a timer function which switches the radio to standby mode after a pre-defined length of time.

13. Settings

• **Audio equaliser**

Here you can select from pre-defined equaliser settings for the device or make your own settings

• **Screen settings – Backlight**

Select the intensity of the backlight in Operating and Standby modes here. Under "**Time-Out**", define the value in seconds after which the backlight switches off during operation

• **Screen settings - Colour scheme**

Choose from various colour schemes for the operating menu

• **Screen settings - Night mode**

Night mode activates a colour scheme adapted especially for operation in dark conditions. You can define whether you want to use night mode and if necessary define a period during which the device automatically switches to night mode. To obtain a preview of night mode, select "**Preview**" - "**On**"

• **System settings - Time / Date**

The time and date can be set either manually or obtained from various sources (DAB/Bluetooth). The time and date format can also be set

• **System settings - Language**

Define the preferred system language

• **System settings - Automatic switch-off**

If there is no signal from the selected audio source, the device switches automatically after a defined period to "**Standby**" mode.

• **System settings - Software update**

Improvements and new features are constantly being developed for the software used in our radios to resolve potential errors, increase the range of functions, and so on. We recommend that you always install any available updates on your radio.

You can find information on performing an update separately on the enclosed sheet and/ or you can download it as a PDF at www.hama.com.

• **System settings - Factory settings**

This menu item resets the device to its factory settings.

14. Factory settings

Note

- Restarting or resetting to the factory default settings can remedy some problems and malfunctions.

To restart the radio, proceed as follows:

- Use a needle or similar object. Press and hold the Reset button (13) for approx. 3 seconds.
- To reset the radio to the factory settings, navigate in the menu to the System settings -> System and select the "Factory settings" option.

Note

- Note that when you reset to the factory settings, all default settings such as language and favourites will be permanently deleted.

Note

- Czech, English, Danish, Dutch, German, Finnish, French, Italian, Norwegian, Polish, Portuguese, Slovak, Spanish, Swedish, Turkish

15. Care and maintenance

Note



Disconnect the device from the mains before cleaning and during prolonged periods of non-use.

- Only clean this product with a slightly damp, lint-free cloth and do not use aggressive cleaning agents.
- If you do not plan to use the product for a prolonged period, turn off the device and disconnect it from the power supply. Store it in a clean, dry place away from direct sunlight.

16. Warranty Disclaimer

Hama GmbH & Co KG assumes no liability and provides no warranty for damage resulting from improper installation/mounting, improper use of the product or from failure to observe the operating instructions and/or safety notes.

17. Service and Support

Please contact Hama Product Consulting if you have any questions about this product.

Hotline: +49 9091 502-115 (German/English)

Further support information can be found here:
www.hama.com

The full text of the manual is available at the following internet address:

www.hama.com -> 00188218 -> Downloads

18. Recycling information

Note on environmental protection:









After the implementation of the European Directives 2012/19/EU and 2006/66/EU in the national legal system, the following applies: electrical and electronic devices as well as batteries must not be disposed of with household waste. Consumers are obliged by law to return electrical and electronic devices as well as batteries to the designated public collection points or to the point of sale at the end of their service lives. Detailed information on this topic is defined in the national laws of the respective country. This presence of the above symbol on the product, operating instructions or package indicates that the product is subject to these regulations. By recycling, reusing the materials or other forms of utilising old devices/batteries, you are making an important contribution to protecting our environment.

19. Declaration of Conformity

CE Hama GmbH & Co KG hereby declares that the radio equipment type [00188218] is in compliance with Directive 2014/53/EU. The full text of the EU declaration of conformity is available at the following internet address:

www.hama.com -> 00188218 -> Downloads

Frequency band(s)	Maximum radio-frequency power transmitted
Bluetooth: 2,402 – 2,480 GHz	2.09 dBm (EIRP)

Favourites management buttons			Active mode / menu				Key function
3	1	[PRESET 1] button	DAB	VHF			Short key press: Call up favourite memory slot 1 for current playback mode Long key press: Save the current station to favourite memory slot 1
4	2	[PRESET 2] button	DAB	VHF			Short key press: Call up favourite memory slot 2 for current playback mode Long key press: Save the current station to favourite memory slot 2
5		[PRESET] button	DAB	VHF			Call up the favourites memory list (1-30) to call up stations Long key press: Call up the favourites memory list (1-30) to save the station currently active as a favourite
General operation							
6		[SETTINGS] button	DAB	BT	VHF	AUX	Short key press: Open the menu of the currently active mode Long key press: Open the device's system settings
			Menu				Back to the playback screen active in the background
7		[POWER] button					Short key press: Wake the radio from standby mode or place it in standby mode Long key press: Switch the radio on or off
8		[MODE] button	DAB	BT	VHF	AUX	Toggle between the operating modes available
9		[NAVIGATE -] button	DAB	BT	VHF	AUX	Short key press: Volume reduction in playback mode
				BT			Long key press: Previous track
			Menu				Menu: Navigation to the previous menu item
10	OK	[ENTER/OK]	DAB				Change the display of the playback screen with a brief key press 1) Split display (picture content on the left - text content on the right) 2) Picture display maximised with information in the footer 3) Picture display full screen
				BT			Short key press: Pause and continue Long key press: Pair new device and disconnect existing connection if necessary
					VHF		The nearest receivable station will be automatically searched for.
						AUX	Not used
			Menu				Menu: Confirmation of the active menu selection
11		[NAVIGATE +] button	DAB	BT	VHF	AUX	Short key press: Volume increase in playback mode
				BT			Long key press: Next track
			Menu				Menu: Navigation to the next menu item
12		[BACK] button	DAB				Short key press: Open station list
					VHF		Short key press: Open the settings menu for VHF radio
			DAB	BT	VHF	AUX	Long key press: Mute the loudspeaker
			Menu				Back to the previous menu

Note: If the description of any of the key functions listed above does not distinguish between a long and short key press, the key press is short. A long key press requires the key to be pressed for approx. 3 seconds.

hama

Hama GmbH & Co KG
86652 Monheim/Germany
www.hama.com

All listed brands are trademarks of the corresponding companies. Errors and omissions excepted, and subject to technical changes. Our general terms of delivery and payment are applied.

00188218/10.22